

# Mutina

# Celosia

by Patricia Urquiola

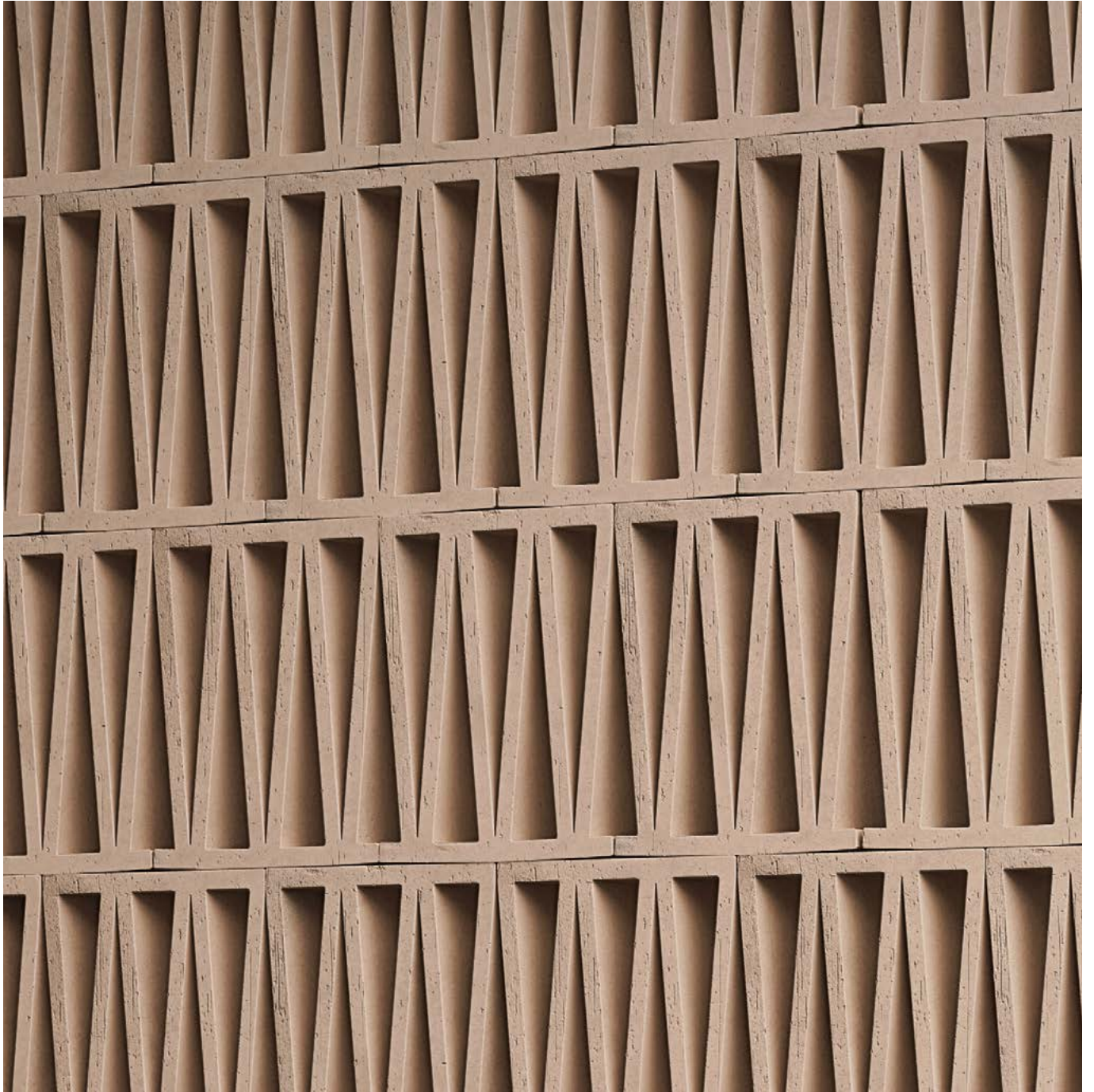

EN

General information

Laying and maintenance tips

Technical features

Packing

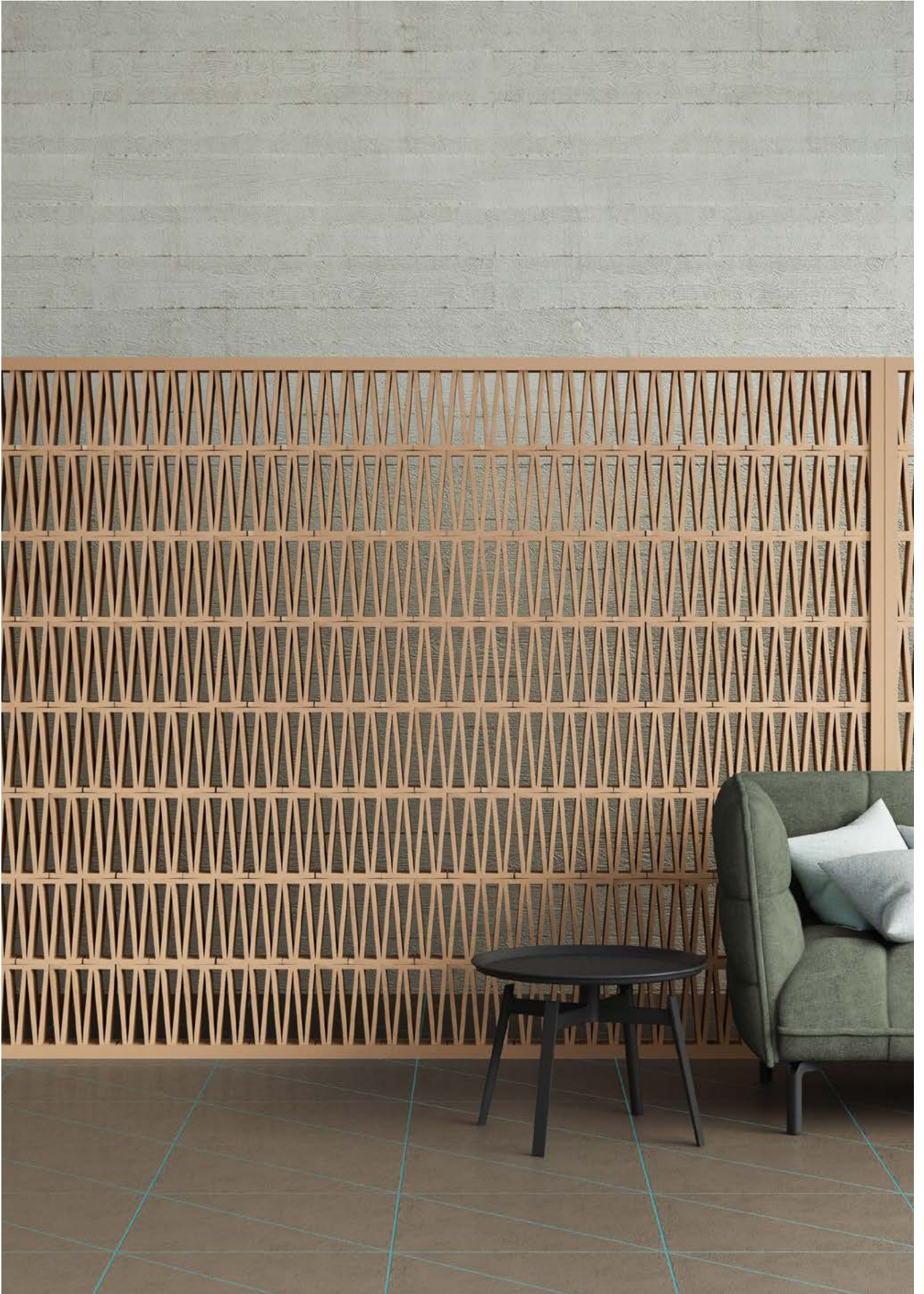

# General information

The data, information and indications contained in this technical data sheet and in further documents relating to the Celosia by Patricia Urquiola product are the exclusive property by Ceramiche MUTINA S.p.a. This Technical Data Sheet provides the buyer with information relating to the use of the product useful for its correct installation and evaluation and prevention of risks arising from the normal use of the same.

collection	Celosia
design	Patricia Urquiola, 2018
production	Artisanal
material	Extruded terracotta
nominal sizes	20,5-26,5-10 cm (8"-10"-4")
specification	<ul style="list-style-type: none"> <li>- Artisanal extruded partition elements, 10cm thick.</li> <li>- This product is suitable for both residential and commercial spaces to construct walls with a maximum height of 4 metres. The buyer is not released from the obligation of checking the information received, and for making design and construction choices in compliance with good construction techniques and regulations, including local ones, in force at the time of use of the product and in the country of final destination. The NTC 2018 DECRETO MIN 27/01 regulation shall apply in Italy.</li> <li>- In order to achieve an optimal aesthetic outcome we advise to install Celosia using our wooden profile. The profile is painted and suitable for outdoor use. A top profile with removable sides is provided for ceiling fixing.</li> <li>- As complementary pieces Mutina provide the Mutina adhesive, EC 1 plus for VOC emissions.</li> <li>- For installation process see the installation video available on <a href="http://www.mutina.it">www.mutina.it</a></li> <li>- The product is suitable for indoor and outdoor areas complying with UNI EN 772-22 marked "F1-moderate exposure".</li> </ul>
complementary pieces	Linear profile 300, top profile 300.
awards	Interior Design's Best of Year 2018 German Design Awards 2020
category	UNI 11128/2004

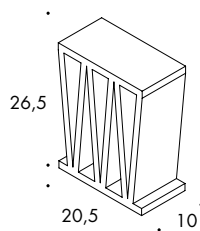

20,5-26,5-10 cm  
8"-10"-4"

## complementary pieces

Linear painted willow profile (also suitable for outdoor use).  
Top painted willow profile (also suitable for outdoor use) with one shaped end to make clamping easier.

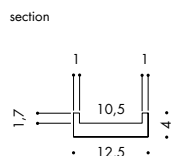
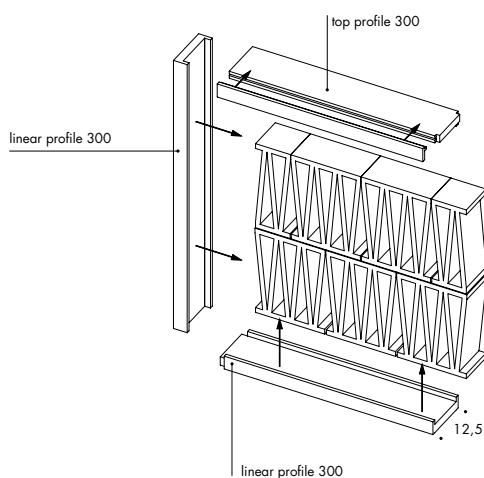

To make the installation of these items easier, a Mutina adhesive is now available: organic, eco-friendly and sold separately.

wall anchoring scheme

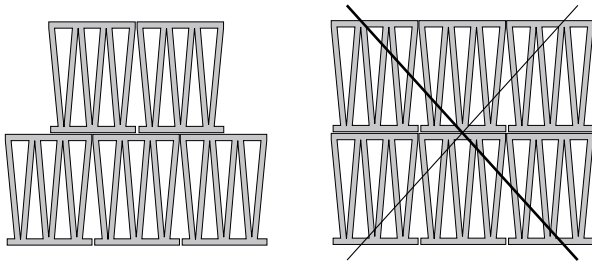

For security reasons only staggered installation is strictly allowed.

Standard installation suggestions have been tested by Mutina and certified by the Giordano Institute. | [DOWNLOAD THE DOCUMENT](#)



Fisher long shaft fixing SXR 8x80

**ANCHORING ON 2 SIDES**  
Max h 400 cm

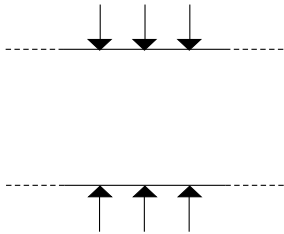

**ANCHORING ON 3 SIDES**  
Max h 400x300 cm

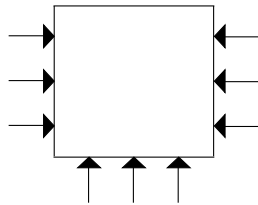

**ANCHORING ON 2 SIDES**  
MAX h250x100 cm

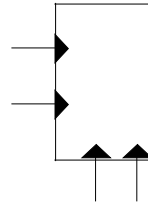

## Laying and maintenance tips

use	Wall – indoor Wall – outdoor in moderate exposure areas only
installation	For security reasons only staggered installation is strictly allowed. For installation process see the installation video available on <a href="http://www.mutina.it">www.mutina.it</a>
recommended adhesive	Mutina adhesive: solvents-free, eco-friendly organic adhesive
recommended joints	-
recommended fillers	-
cleaning at the end of installation	Avoid drippings during installation. If needed the excess can be removed after the product has dried, using a tool with a sharp edge.
general cleaning (installed tiles)	-
calibers (real size)	20,5 x 26,5 x 10 cm with 1-3 mm tolerance (artisanal product)

## Colors



## Technical features

STANDARD	FEATURES	VALUE REQUIRED	CELOSIA
UNI EN 772-16	dimensions	to declare	T2 – R2
UNI EN 772-21:2011	water absorption	to declare	12.5%
UNI EN 772-5:2016	content of active soluble salts	to declare	S2
UNI EN CEN/TS 772- 22:2006	freeze-thaw resistance	to declare	F1
D.M. 1401/2008	determination of horizontal variable loads	to declare	C2
<b>LEED CERTIFICATION 4.1</b>			10% recycled material
<b>VOC EMISSION</b>			available upon request
<b>DECLARATION OF CONTENTS</b>			available upon request
<b>SDS</b>			available upon request
<b>BPD3</b>			available upon request
<b>HDP</b>			available upon request

## Packing

SIZE	PCS-SQM	PCS-PAL	SQM-PAL	KG-PC	KG-PAL
20,5-26,5-10 cm	18,41	32	1,74	5,50	176,00